

# Fiber Optic Sensing Solutions

**BANNER**<sup>®</sup>  
more sensors, more solutions

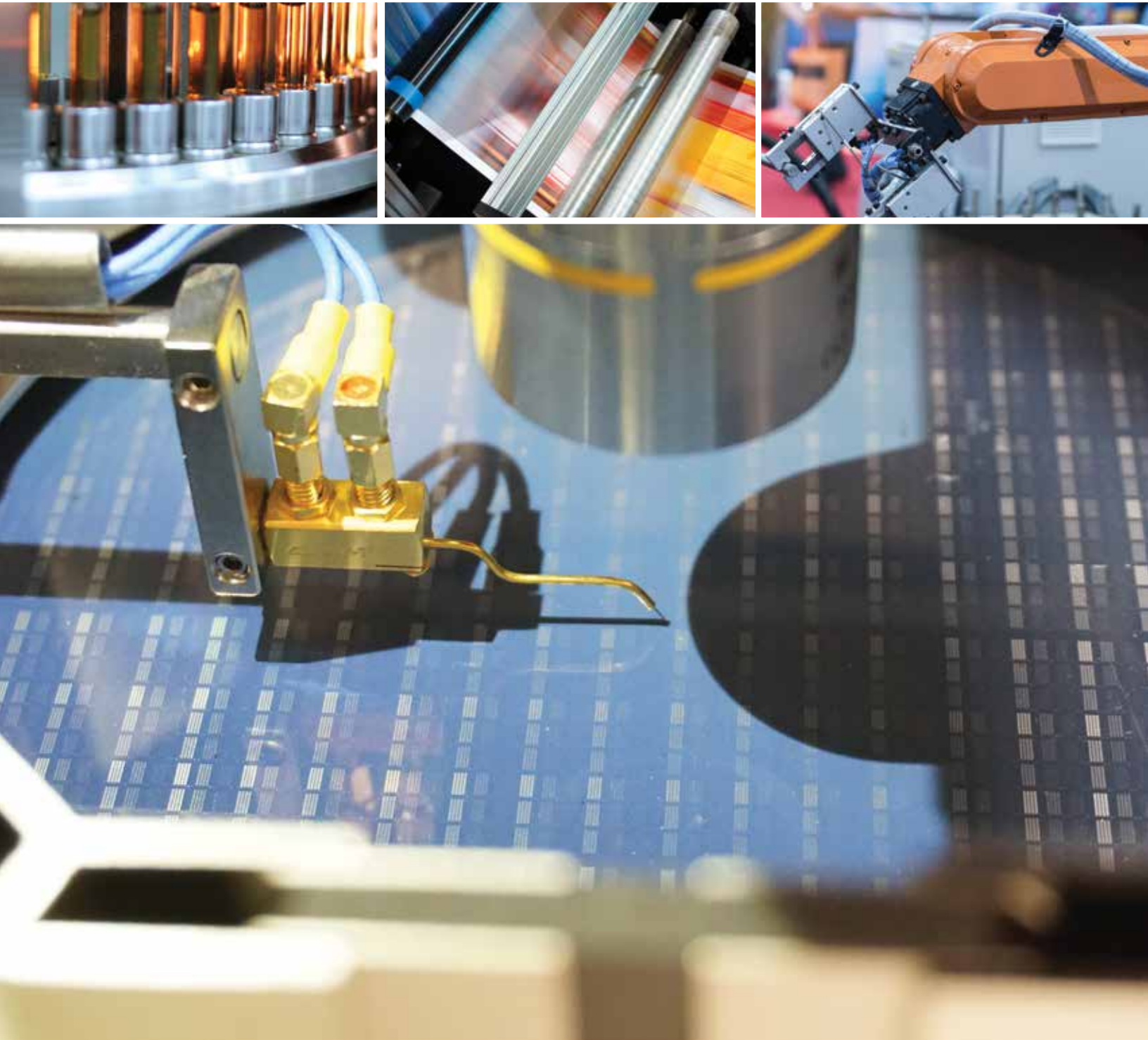

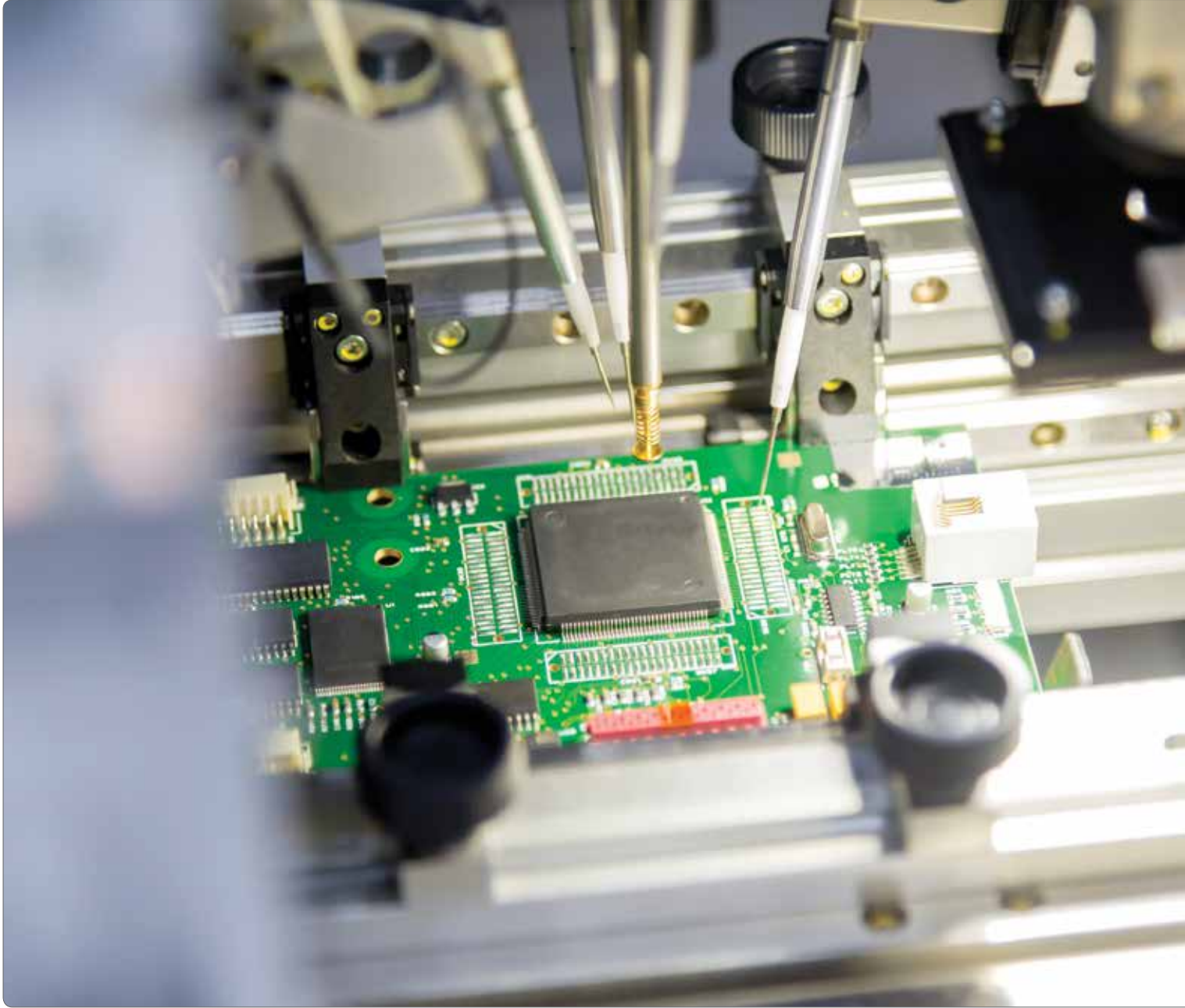



# Contents

<b>Fiber Amplifiers</b> .....	4
General Purpose .....	6
Application Specific .....	8
<b>Applications</b> .....	10
<b>Fiber Optics</b> .....	16
Vantage Line .....	18
Array & Slot .....	20
Heavy Duty .....	22
Tight Bend .....	24
Retractable .....	25
Liquid Level .....	26
High Temperature .....	27

# What is a Fiber Optic System?



## Considerations for Choosing Fiber Optic Technology

Fiber Optic systems are comprised of a fiber amplifier and optical fibers. The amplifier, or sensor, emits, receives, and converts the light energy into an electrical signal. Individual fiber optic assemblies simply guide light from the amplifier to a sensing location, or from the sensing location back to the amplifier.

Think of an optical fiber as being similar to a garden hose: like a hose transports water, the fiber transports light from one end to the other.

The main advantage of fiber optic sensors is the versatility. Fibers are typically used because of space constraints, hostile environments, or lack of power at the sensing location. Since the fiber amplifier is a separate piece, it can be mounted and powered remotely.

Banner Engineering has the largest portfolio of fiber optic assemblies in the Industry. We have over 1,000 different fibers to meet every space, environment and sensing requirement.

## Typical Applications for Fiber Optics

- Punch presses
- Vibratory feeders
- Conveyors
- Pill counting
- Small object detection
- Leading edge detection
- Ovens
- Semiconductor processing equipment
- Robotic arms and moving machines
- Edge guiding
- Hazardous locations
- Final inspection stations

# Why Fiber Optics?

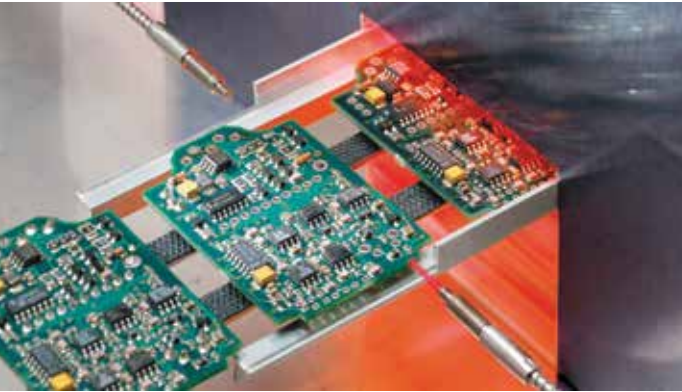

## Compact Size for Tight Sensing Locations

- The small size and flexibility allow positioning and mounting in tight spaces
- Plastic fiber optic assemblies are usually single strands of optical fiber and can be routed into extremely tight areas
- Plastic fibers also survive well under repeated flexing
- Pre-coiled plastic fiber optics are available for sensing applications on reciprocating mechanisms

## Reliable Performance in Harsh or Explosive Environments

- Fibers can be constructed to survive in areas with corrosive material or extreme moisture and are immune to electrical noise
- Fiber optics contain no electrical circuitry and have no moving parts, so they can safely “pipe” light into and out of hazardous sensing locations
- Most glass fiber optic assemblies are very rugged and perform reliably in extreme temperatures
- Sheathing materials such as polypropylene, Teflon®, and stainless steel are used to shield both plastic and glass fiber optic assemblies in harsh environments
- Optical fibers are low in mass, enabling fiber optic assemblies to withstand high levels of vibration and mechanical shock

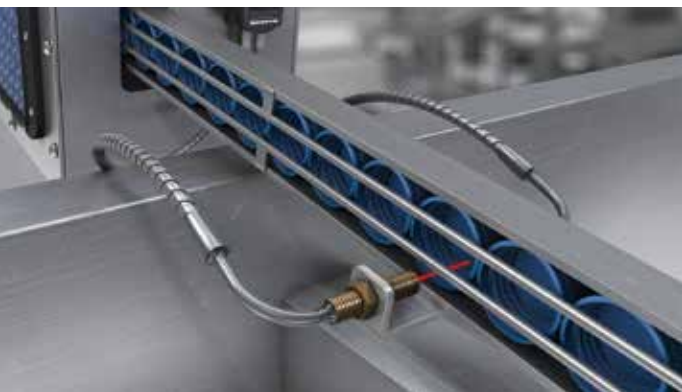















## Flexibility to Meet a Wide Variety of Application Requirements

- Some fiber optics have bendable probes that can be optimally shaped to the physical and optical requirements of a specific application
- Specialty fibers are available for water detection, clear object detection, or for vacuum feed-through areas

# Overview of DF-G Series Amplifiers



- The DF-G Series is an easy-to-use DIN-rail-mountable fiber optic sensor.
- It provides high-performance sensing in low-contrast applications.
- The sensor's compact housing has dual digital displays (Red/Green) and a bright output LED for easy programming and status monitoring during operation.
- Specifications are available on page 15 or on [www.bannerengineering.com](http://www.bannerengineering.com)

	DF-G1	DF-G2	DF-G3
Outputs	 Discrete	 Discrete	 Discrete and Analog
LED Colors			
IO-Link	 <b>IO-Link®</b>	 <b>IO-Link®</b>	 <b>IO-Link®</b>
Light Intensity Receiver			
Small Object Counting			
Extremely Fast Response Speed			
High Power			
Water Detection			

Simple user interface. Highly visible dual display. Easy sensor set up.

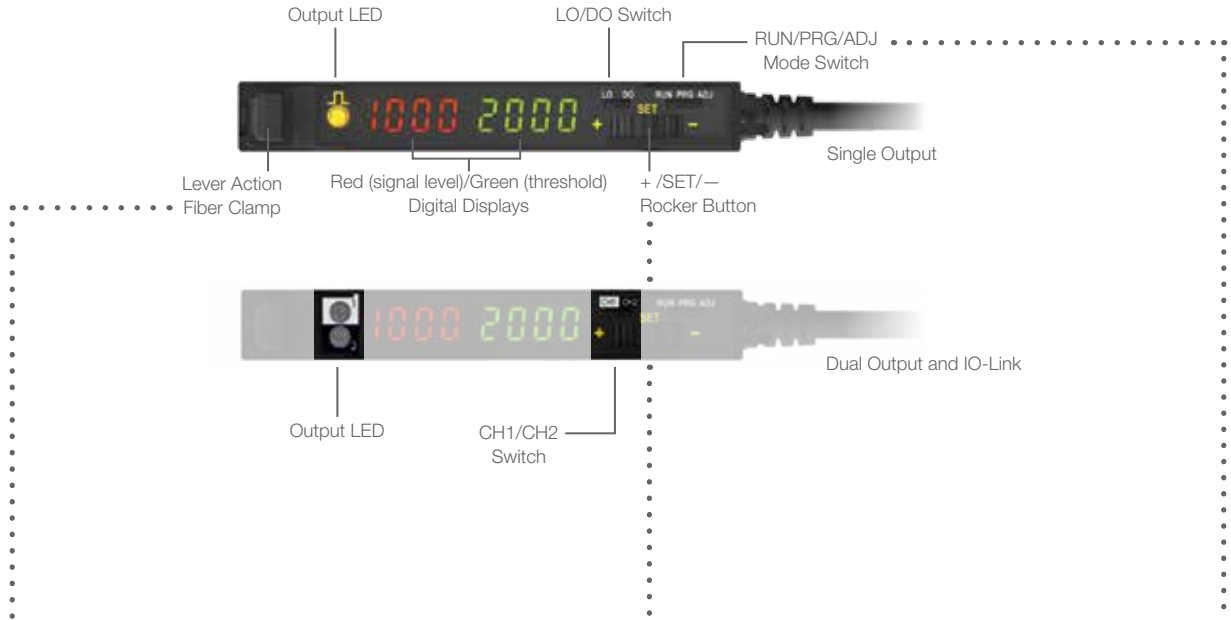

• • • Lever Action Fiber Clamp

- Push lever downward to open
- Upward to close

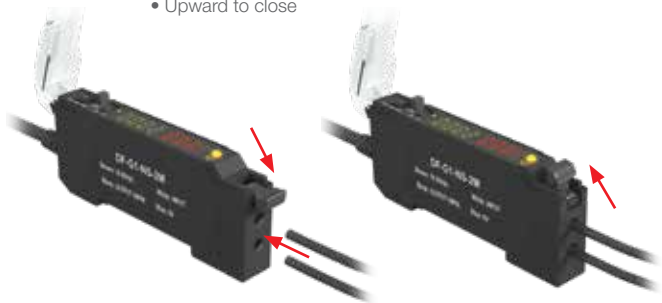

User Interface

- Light Operate and Dark Operate Slide Switch is easy to see and change the selection
- Run, Program and Adjust Mode Switch
  - RUN locks out changes
  - PROGRAM (PRG) allows for full sensor configuration
  - ADJUST (ADJ) enables threshold adjust and teaching



Rocker Button

- Three position Jog Switch
  - Rocker Switch (+) and (-) precisely adjusts thresholds and easily navigate menus
  - Press to click initiates Teach and SETs, and allow selection of displayed menu



# General Purpose Amplifiers

## DF-G1: Single Discrete Output

Sensing Beam Color	Connection	Range	NPN Model	PNP Model
Visible red	2 m	Range varies by response speed used, gain setting, target light source intensity, ambient light level and with fiber optics used.	DF-G1-NS-2M	DF-G1-PS-2M
	9 m		DF-G1-NS-9M	DF-G1-PS-9M
	150 mm (6 in) PVC pigtail, M8 Pico connector, 4-pin		DF-G1-NS-Q3	DF-G1-PS-Q3
	150 mm (6 in) PVC pigtail, M12 Euro QD connector, 4-pin		DF-G1-NS-Q5	DF-G1-PS-Q5
	Integral M8 Pico, 4-pin		DF-G1-NS-Q7	DF-G1-PS-Q7

## DF-G2: High-Speed Single Discrete Output

Sensing Beam Color	Connection	Range	NPN Model	PNP Model
Visible red	2 m	Range varies by response speed used, gain setting, target light source intensity, ambient light level and with fiber optics used.	DF-G2-NS-2M	DF-G2-PS-2M
	9 m		DF-G2-NS-9M	DF-G2-PS-9M
	150 mm (6 in) PVC pigtail, M8 Pico connector, 4-pin		DF-G2-NS-Q3	DF-G2-PS-Q3
	150 mm (6 in) PVC pigtail, M12 Euro QD connector, 4-pin		DF-G2-NS-Q5	DF-G2-PS-Q5
	Integral M8 Pico, 4-pin		DF-G2-NS-Q7	DF-G2-PS-Q7

## DF-G3: High-Power Single Discrete Output

Sensing Beam Color	Connection	Range	NPN Model	PNP Model
Visible red	2 m	Range varies by response speed used, gain setting, target light source intensity, ambient light level and with fiber optics used.	DF-G3-NS-2M	DF-G3-PS-2M
	9 m		DF-G3-NS-9M	DF-G3-PS-9M
	150 mm (6 in) PVC pigtail, M8 Pico connector, 4-pin		DF-G3-NS-Q3	DF-G3-PS-Q3
	150 mm (6 in) PVC pigtail, M12 Euro QD connector, 4-pin		DF-G3-NS-Q5	DF-G3-PS-Q5
	Integral M8 Pico, 4-pin		DF-G3-NS-Q7	DF-G3-PS-Q7

A model with a QD connector requires a mating cordset



## DF-G3: High-Power Dual Independent Discrete Outputs

Sensing Beam Color	Connection	Range	NPN Model	PNP Model
Visible red	2 m	Range varies by response speed used, gain setting, target light source intensity, ambient light level and with fiber optics used.	DF-G3-ND-2M	DF-G3-PD-2M
	9 m		DF-G3-ND-9M	DF-G3-PD-9M
	150 mm (6 in) PVC pigtail, M8 Pico connector, 5-pin		DF-G3-ND-Q3	DF-G3-PD-Q3
	150 mm (6 in) PVC pigtail, M12 Euro QD connector, 5-pin		DF-G3-ND-Q5	DF-G3-PD-Q5
	Integral M8 Pico, 5-pin		DF-G3-ND-Q7	DF-G3-PD-Q7

## DF-G3: High-Power One Analog and One Discrete Output

Sensing Beam Color	Connection	Analog Output	Range	NPN Model	PNP Model
Visible red	2 m	Voltage: 0-10 V DC	Range varies by response speed used, gain setting, target light source intensity, ambient light level and with fiber optics used.	DF-G3-NU-2M	DF-G3-PU-2M
	9 m	Voltage: 0-10 V DC		DF-G3-NU-9M	DF-G3-PU-9M
	150 mm (6 in) PVC pigtail, M8 Pico, 5-pin	Voltage: 0-10 V DC		DF-G3-NU-Q3	DF-G3-PU-Q3
	150 mm (6 in) PVC pigtail, M12 Euro, 5-pin	Voltage: 0-10 V DC		DF-G3-NU-Q5	DF-G3-PU-Q5
	Integral M8 Pico, 6-pin	Voltage: 0-10 V DC		DF-G3-NU-Q7	DF-G3-PU-Q7
Visible red	2 m	Current: 4-20 mA	Range varies by response speed used, gain setting, target light source intensity, ambient light level and with fiber optics used.	DF-G3-NI-2M	DF-G3-PI-2M
	9 m	Current: 4-20 mA		DF-G3-NI-9M	DF-G3-PI-9M
	150 mm (6 in) PVC pigtail, M8 Pico, 5-pin	Current: 4-20 mA		DF-G3-NI-Q3	DF-G3-PI-Q3
	150 mm (6 in) PVC pigtail, M12 Euro QD, 5-pin	Current: 4-20 mA		DF-G3-NI-Q5	DF-G3-PI-Q5
	Integral M8 Pico, 6-pin	Current: 4-20 mA		DF-G3-NI-Q7	DF-G3-PI-Q7

A model with a QD connector requires a mating cordset\

# Application Specific Amplifiers

## DF-G1 Light Intensity Receiver

Connection*	Range	NPN Models	PNP Models
2 m	Range varies by response speed used, gain setting, target light source intensity, ambient light level and with fiber optics used.	DF-G1-NR-2M	DF-G1-PR-2M

## DF-G2 Small Object Counter

Connection*	Sensing Beam Color	Window Size	NPN Models	PNP Models**
2 m	Visible red	Determined by the fiber optic assembly	DF-G2-NC-2M	DF-G2-PC-2M

See page 20 for a sample of array fibers

## DF-G2 Color LED

Connection*	Sensing Beam Color	Range	NPN Models	PNP Models
2 m	Infrared <sup>†</sup>	190% of Visible Red Range	DF-G2IR-NS-2M	DF-G2IR-PS-2M
2 m	Broad spectrum white	50% of Visible Red Range	DF-G2W-NS-2M	DF-G2W-PS-2M
2 m	Visible green	60% of Visible Red Range	DF-G2G-NS-2M	DF-G2G-PS-2M
2 m	Visible blue	70% of Visible Red Range	DF-G2B-NS-2M	DF-G2B-PS-2M

## DF-G3 Water Detection

Connection*	Sensing Beam Color	Range <sup>††</sup>	Output	NPN Models	PNP Models
2 m	Long infrared (1450 nm) <sup>†</sup>	900 mm	Voltage: 0-10 V DC, Discrete	DF-G3LIR-NU-2M	DF-G3LIR-PU-2M
2 m	Long infrared (1450 nm) <sup>†</sup>	900 mm	Current: 4-20 mA, Discrete	DF-G3LIR-NI-2M	DF-G3LIR-PI-2M
2 m	Long infrared (1450 nm) <sup>†</sup>	900 mm	Single Discrete	DF-G3LIR-NS-2M	DF-G3LIR-PS-2M
2 m	Long infrared (1450 nm) <sup>†</sup>	900 mm	Dual Discrete	DF-G3LIR-ND-2M	DF-G3LIR-PD-2M

A model with a QD connector requires a mating cordset

\* Connector options:

- For 9 m cable, change the suffix **2M** to **9M** in the 2 m model number (example, **DF-G3LIR-NU-9M**)
- For 150 mm (6 in) PVC, M8 Pico QD connector, 4-pin change the suffix **2M** to **Q3** in the 2 m model number (example, **DF-G3LIR-NU-Q3**)
- For 150 mm (6 in) PVC, M12 Euro QD connector, 4-pin change the suffix **2M** to **Q5** in the 2 m model number (example, **DF-G3LIR-NU-Q5**)
- For integral M8 Pico QD connector, 4-pin change the suffix **2M** to **Q7** in the 2 m model number (example, **DF-G3LIR-NU-Q7**)

\*\* Includes Health Mode Output

<sup>†</sup> Excess gain = 1, Long Range response speed, opposed mode sensing. PIT46U plastic fiber used for visible LED models, IT.83.3ST5M6 glass fiber used for IR model

<sup>††</sup> IR models require T5 terminated glass fiber optic cables



## DF-G Fiber Amplifiers with IO-Link

The DF-G Series has a simple user interface to ensure easy sensor set-up and programming via displays and switches/buttons, remote input teach wire or IO-Link.

### DF-G1

Connection*	Sensing Beam Color	Range	Output	Model*
150 mm (6 in) PVC pigtail, M12 Euro, 5-pin	Visible red	Range varies by Speed Selection used and with fiber optics used	Dual complementary outputs: - 1 push-pull (IO-Link) - 1 PNP	DF-G1-KS-Q5

### DF-G2

Connection*	Sensing Beam Color	Range**	Channel 1 Output	Channel 2 Output	Model*
150 mm (6 in) PVC pigtail, M12 Euro, 5-pin	Visible red	1100 mm	IO-Link, push/pull	PNP only, or input	DF-G2-KD-Q5
150 mm (6 in) PVC pigtail, M12 Euro, 5-pin	Infrared†	2100 mm	IO-Link, push/pull	PNP only, or input	DF-G2IR-KD-Q5

### DF-G3

Connection*	Sensing Beam Color	Range**	Channel 1 Output	Channel 2 Output	Model*
150 mm (6 in) PVC pigtail, M12 Euro, 5-pin	Visible red	3000 mm	IO-Link, push/pull	PNP only, or input	DF-G3-KD-Q5
150 mm (6 in) PVC pigtail, M12 Euro, 5-pin	Infrared†	6000 mm	IO-Link, push/pull	PNP only, or input	DF-G3IR-KD-Q5

A model with a QD connector requires a mating cordset

\* Connector options:

- For 2 m cable, change the suffix **Q5** to **2M** in the **Q5** model number (example, **DF-G3-KD-9M**)
- For 9 m cable, change the suffix **Q5** to **9M** in the **Q5** model number (example, **DF-G3-KD-9M**)
- For 150 mm (6 in) PVC, M8 Pico QD connector, 4-pin change the suffix **Q5** to **Q3** in the **Q5** model number (example, **DF-G3-KD-Q3**)
- For integral M8 Pico QD connector, 4-pin change the suffix **Q5** to **Q7** in the **Q5** model number (example, **DF-G3-KD-Q7**)

\*\* Excess gain = 1, Long Range response speed, opposed mode sensing, **PIT46U** plastic fiber used for visible LED models, **IT.83.3ST5M6** glass fiber used for IR model

† IR models require T5 terminated glass fiber optic cables

# Fiber Optic Applications

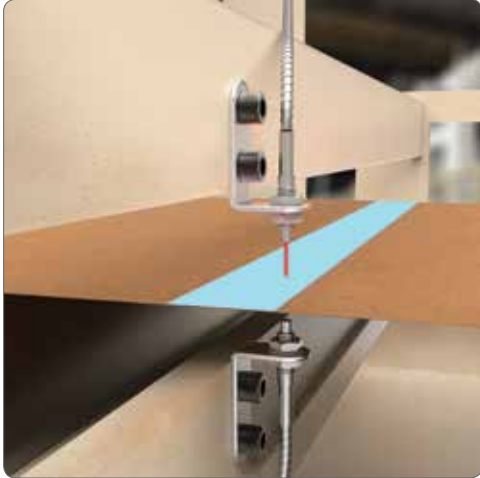

## Web Monitoring/Splice Detection

### Challenge

- Material texture, color, or finish vary
- Dusty environment
- Easy setup

### Key Features

- Variety of opposed mode fiber arrays for edge guiding
- High excess gain with auto thresholding
- Option for mid-point teach mode

### Featured Solution

Amplifier: DF-G2-PS-2M  
Fiber: PIT43TSL5-VL

### Key Benefits

- Opposed mode fiber arrays minimize effects of changing textures, colors, or transparencies
- Able to burn through dust and compensate for dust that settles on fibers
- Mid-point teach learns the optimal web position with an easy single-point teach



## Liquid Level Detection

### Challenge

- Detect liquid level in transparent or different color vials and bottles
- Limited space to mount a sensor

### Key Features

- Detect water-based liquids inside translucent or opaque plastic and glass containers
- Compatible with standard glass fibers with T5 termination

### Featured Solution

Amplifier: DF-G3LIR-PS-2M  
(Water Detection Sensor)  
Fiber: IT43ST5-VL (pair)

### Key Benefits

- Reduce product waste by detecting under-filled vials early in the packaging process
- Quick and simple installation with many small fiber optic bundle styles to choose from



## Light Intensity Detection

### Challenge

- Verify correct assembly and function of automotive indicator lights

### Key Features

- Designed to detect light emission from a wide variety of sources - 410 nm to near infrared

### Featured Solution

Amplifier: DF-G1-PR-Q5  
Fiber: PIT46U-VL

### Key Benefits

- Quality improvement and return reduction
- Quick and simple installation with many small fiber optic bundle styles to choose from

### Related Applications

- Appliance lighting
- LED indicators on equipment
- Window tint verification
- Dashboard lighting verification

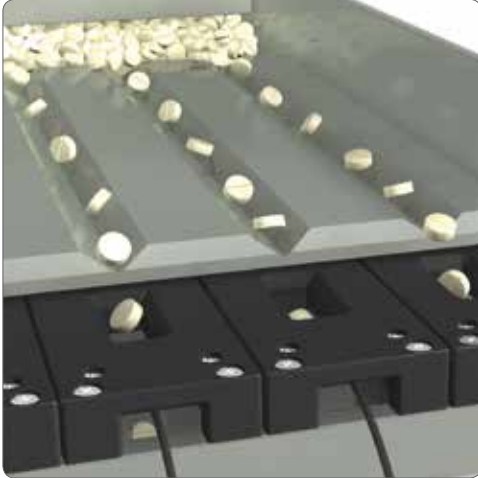

## High-Speed Small Object Detection

### Challenge

- Tablets move at high speed
- Small tablets are hard to detect

### Featured Solution

Amplifier: DF-G2-PC-2M (small object counter)  
Fiber: PFCVA-10X25-E

### Key Features

- Automatic Gain Compensation (AGC) algorithm compensates for dust build-up on fiber optics
- Fiber optic array can detect objects as small as 2 mm in diameter

### Key Benefits

- Increase the time between scheduled maintenance by extending the counting cycle and maintain count accuracy as dust increases during production
- Improve process flexibility by detecting even the smallest tablet in a large 40 mm area

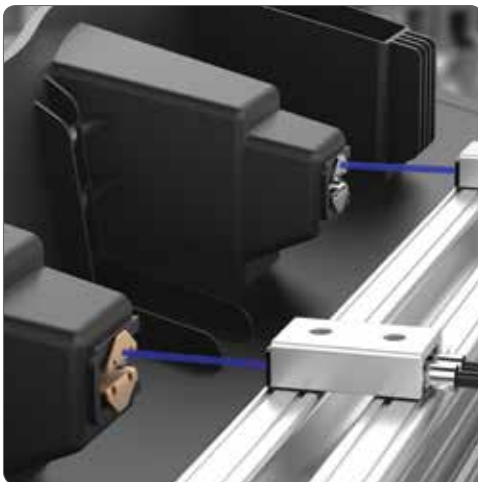

## Blue LEDs for Low Contrast Detection

### Challenge

- Detecting presence and correct clips used in a door panel assembly

### Featured Solution

Amplifier: DF-G2B-PS-Q5 (Blue LED)  
Fiber: PBL46U

### Key Features

- Blue LED optimal for detecting silver and gold clips in place
- Can easily differentiate and verify correct color clip used since gold clips reflect less blue light than silver

### Key Benefits

- Highly reliable and cost-effective solution to reduce errors and rejects
- Diffuse lensed fibers provide small, bright spot

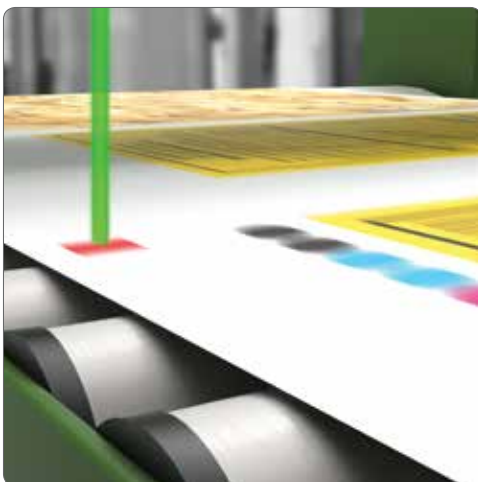

## Green LEDs for Registration Mark Detection

### Challenge

- Accurately detect red registration mark on roll of packaging
- Product passes at high speed

### Featured Solution

Amplifier: DF-G2G-PS-2M  
Fiber: PBT23U-VL

### Key Features

- 10  $\mu$ s response time

### Key Benefits

- Green LED creates optimal contrast with red registration mark

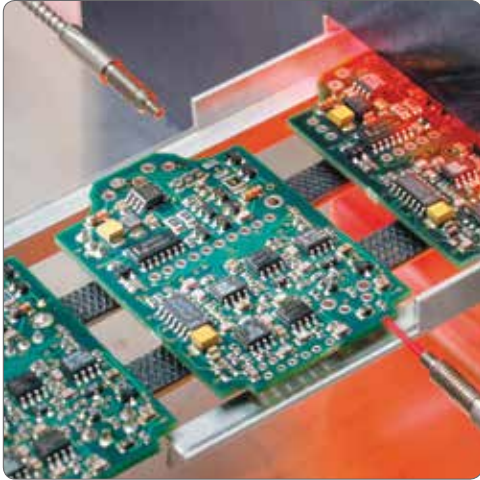

## High Temperature – Leading Edge Detection

### Challenge

- Temperature is above the limit for most plastic fibers

### Key Features

- Glass fiber assemblies are suitable for high temp applications up to 249° C
- Stainless steel sheathing protects cable jacket from abrasion and high temperature

### Featured Solution

Amplifier: DF-G1-PS-Q3  
Fiber: One pair of IT46ST5-VL

### Key Benefits

- Thermal process applications
- For sensing near manufacturing ovens
- Manufacturing of solar panels, colored glass and ceramics
- Widest selection of plastic and glass fibers for high temp applications



## Long-Range Detection in a Hazardous/Dirty Area

### Challenge

- Detecting correct product placement in harsh environment, fibers get coated in oil and dirt
- Cables can be abraded or cut

### Key Features

- With extended range of DF-G3 amplifier, fibers can be placed much farther away and still reliably detect correct positioning

### Featured Solution

Amplifier: DF-G3-PS-Q5  
Fiber: PIT46TMB5

### Key Benefits

- No build-up of dirt and oil on fiber amplifier because it is out of the area
- STEEL SKIN fibers offer protection to the cabling

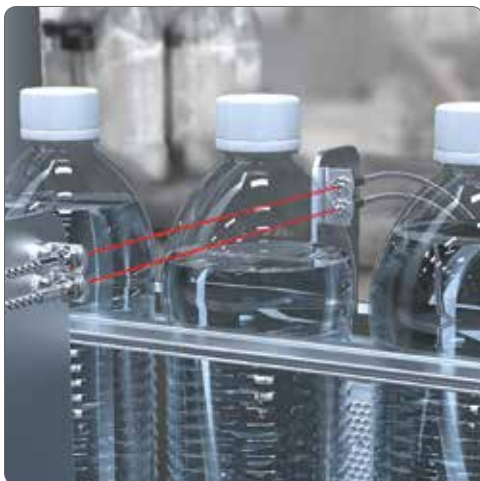

## Fill Level Detection – Water Bottles

### Challenge

- Difficult to consistently detect the top edge of clear water in a variety of bottles

### Key Features

- Banner's DF-G3LIR water sensor employs a unique LED that can clearly detect water-based liquids

### Featured Solution

Amplifier: Two DF-G3LIR-PS-2M  
Fiber: Two pairs of IT43ST5-VL with L2 Lens

### Key Benefits

- Regardless of the bottle color or texture, the DF-G3LIR water sensors will see the clear water-based liquids inside



## Precise Positioning

### Challenge

- Detect leading edge of board to trigger adhesive application
- Then verify that adhesive was applied properly to trays of IC chips

### Key Features

- Fast response speed
- Small spot size

### Featured Solution

Amplifier: Two DF-G3-PD-2M  
Fiber: Two PBT23UM4-VL Diffuse Reflective

### Key Benefits

- Accurate leading edge detection
- Prevents product waste by assuring glue was applied

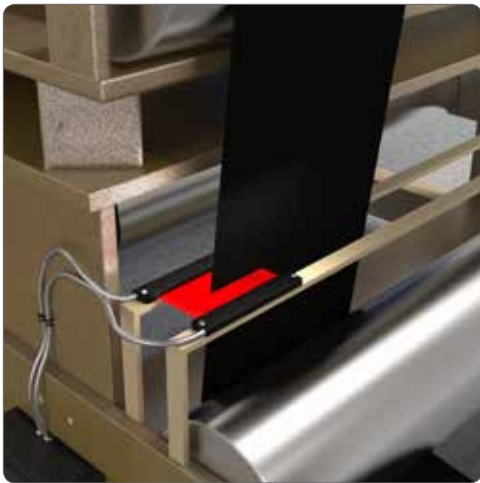

## Edge Guiding

### Challenge

- Incorrect winding causes major issues with assembly and increased downtime to fix the film

### Key Features

- Compact fibers can sense very slight changes in position

### Featured Solution

Amplifier: DF-G3-PU-Q5  
Fiber: PGIRS66U-100

### Key Benefits

- The DF-G3 fiber optic amplifier used with plastic array fibers detects the edges of the film and guides it into proper position

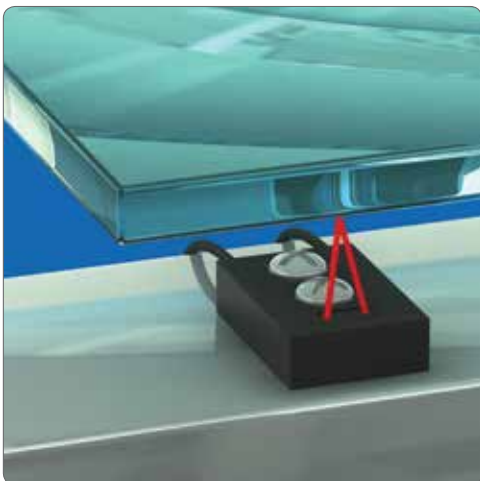

## Detecting Presence of Clear Photomask – Semiconductor Manufacturing

### Challenge

- Clear object in a confined space

### Key Features

- Convergent Beam Fiber can detect glass regardless of color or transparency
- Form factor (right angle) of fiber fits in a confined space
- 6 mm focus point with tight depth of field

### Featured Solution

Amplifier: DF-G1-PS-Q7  
Fiber: P32-C6

### Key Benefits

- Solution is extremely robust based on optical contrast

# Fiber Amplifier Accessories



**SA-DIN-BRACKET**  
to mount DF-G without DIN rail



**SA-DIN-CLAMP**  
end clamps for DIN rail



**DIN-35-70:** 70 mm  
**DIN-35-105:** 105 mm  
**DIN-35-140:** 140 mm  
**DIN-35-180:** 180 mm  
**DIN-35-220:** 220 mm

pre-cut DIN Rail



**4-pin Euro QD**  
(for ..Q5 models)

Straight connector models listed; for right-angle, add **RA** to the end of the model number (ex, **MQDC-406RA**)

**MQDC-406**  
2 m (6')  
**MQDC-415**  
5 m (15')  
**MQDC-430**  
9 m (30')



**5-pin Euro QD**  
(for ..Q5 models)

Straight connector models listed; for right-angle, add **RA** to the end of the model number (ex, **MQDC1-506RA**)

**MQDC1-506**  
2 m (6')  
**MQDC1-515**  
5 m (15')  
**MQDC1-530**  
9 m (30')



**4-Pin Pico QD**  
(for ..Q7 and ..Q3 models)

Straight snap-lock coupling

**PKG4-2**  
2 m (6')  
**PKG4-5**  
2 m (15')



**5-Pin Threaded Pico QD**  
(for ..Q7 and ..Q3 models)

Threaded straight connector

**PKG5M-2**  
2 m (6')  
**PKG5M-5**  
5 m (15')  
**PKG5M-9**  
9 m (30')

**Pico QD** (for ..Q7 and ..Q3 models)

Right-angle snap-lock coupling

**PKW4Z-2**  
2 m (6')  
**PKW4Z-5**  
2 m (15')

**Pico QD** (for ..Q7 and ..Q3 models)

Threaded right-angle connector

**PKW5M-2**  
2 m (6')  
**PKW5M-5**  
5 m (15')  
**PKW5M-9**  
9 m (30')



**6-Pin Pico QD**  
(for ..Q7 and ..Q3 models)

Straight snap-lock coupling

**PKG6Z-2**  
2 m (6')  
**PKG6Z-9**  
9 m (30')



**4-Pin Threaded Pico QD**  
(for ..Q7 and ..Q3 models)

Threaded straight connector

**PKG4M-2**  
2 m (6')  
**PKG4M-5**  
2 m (15')  
**PKG4M-9**  
9 m (30')

**Pico QD** (for ..Q7 and ..Q3 models)

Right-angle snap-lock coupling

**PKW6Z-2**  
2 m (6')  
**PKW6Z-9**  
9 m (30')

**Pico QD** (for ..Q7 and ..Q3 models)

Threaded right-angle connector

**PKW4M-2**  
2 m (6')  
**PKW4M-5**  
2 m (15')  
**PW4MM-9**  
9 m (30')







# Fiber Optics

## What Are Fiber Optics?

Fiber optics are used to transmit light energy over long distances. Optical fibers are thin, transparent strands of optical quality glass or plastic that can be as thin as a strand of hair. In photoelectric sensing, these fibers are used to transmit and/or receive light from the LED of a sensor.

### Plastic Fiber Optic Assemblies

Plastic fiber optics usually have a large, monofilament core which comes in a single strand of fiber optic.

Advances in LED technology have improved the performance and range of plastic fiber optic sensing systems to the point that they are nearly equivalent to glass fibers. Plastic fibers are a versatile, cost-effective choice for many fiber optic sensing applications.



#### Advantages:

- Less expensive
- Allow less signal attenuation
- More flexible
- Survive well under repeated flexing
- Can be cut to length in the field
- Can be routed into extremely tight areas

### Glass Fiber Optic Assemblies

Most glass fiber optic assemblies are very rugged and perform reliably in extreme temperatures, corrosive or vacuum chamber environments. Glass fiber optic assemblies can transmit both visible and infrared light, where plastic fiber optics can only transmit visible light. A common problem experienced with glass fibers is breakage of the individual strands resulting from sharp bending or continued flexing, as occurs on reciprocating mechanisms. Banner glass fibers with a T5 connection are compatible with DF-G plastic amplifiers.

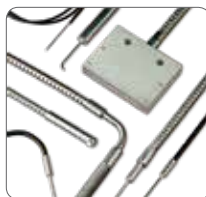

#### Advantages

- Powerful and very rugged
- Can carry infrared light to provide longer range
- Reliable in extreme temperatures and harsh environments

A full line of glass fibers and compatible amplifiers are available on [www.bannerengineering.com](http://www.bannerengineering.com)



### Vantage Line

See page 18

Problem solving fibers that solve a majority of common applications. Most models feature a PVC overmolded flex relief.



### Array & Slot

See page 20

Array fibers are ideal for small part counting and detecting objects at any point in the sensing area. Slot fibers are ideal for web guiding and edge detection.



### Heavy Duty

See page 22

Heavy duty fiber models resist kinking, cutting and abrasion and are ideal for places where the fibers are exposed to repeated stress.



### Tight Bend

See page 24

Able to be bent to a tight radius for limited space set-ups and difficult-to-access locations.

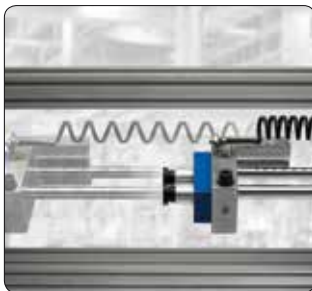

### Retractable

See page 25

Designed for linear motion applications where the fiber is repeatedly moved back and forth. The cable is coiled and can offer a full range of movement without a tangle of loose cable.



### Liquid Level

See page 26

Easily detect liquids with tube mounted fiber assemblies, special wavelength infrared light, or liquid probes.



### High Temperature

See page 27

Glass fibers specially terminated for use in the DF-G Fiber Amplifiers. Can withstand temperatures up to 315 °C – much higher than plastic fibers. For thermal process applications, areas near ovens or high heat.



### Accessories

See page 28

Screw on lenses to focus the light beam are available for a variety of fibers. Also available are special brackets for mounting and fiber cutters to custom fit fiber cables to the application.



# Vantage Line Fibers

- OEM friendly packaging
- No fiber cutter included
- Opposed models come as a pair

## Opposed Fibers

Fiber Head	Description	Minimum Bend Radius	Typical Range* (mm)	Fiber Length	Model
 M6	<ul style="list-style-type: none"> <li>• Plastic fiber with flex relief</li> <li>• Integrated glass lens</li> <li>• 20 mm spot size at 100 mm</li> <li>• Threaded Stainless steel</li> </ul>	15 mm	DF-G1 1260	1 m	PITL23UM6-VL
			DF-G2 1760		PITL26UM6-VL
			DF-G3 4000	2 m	
 M4	<ul style="list-style-type: none"> <li>• Plastic fiber with flex relief</li> <li>• Integrated glass lens</li> <li>• 30 mm spot size at 100 mm</li> <li>• Threaded Stainless steel</li> </ul>	15 mm	DF-G1 670	1 m	PITL23UM4-VL
			DF-G2 1765		PITL26UM4-VL
			DF-G3 4000	2 m	
 M3	<ul style="list-style-type: none"> <li>• Plastic fiber with flex relief</li> <li>• 0.5 mm core diameter</li> <li>• Threaded nickel plated brass</li> </ul>	15 mm	DF-G1 80	1 m	PIT23U-VL
			DF-G2 205		PIT26U-VL
			DF-G3 750	2 m	
 M4	<ul style="list-style-type: none"> <li>• Plastic fiber with flex relief</li> <li>• 0.5 mm core diameter</li> <li>• Threaded nickel plated brass</li> <li>• M2.6 threaded lens mount</li> </ul>	15 mm	DF-G1 65	1 m	PIT23UM4-VL
			DF-G2 170		PIT26UM4-VL
			DF-G3 630	2 m	
 M3	<ul style="list-style-type: none"> <li>• Plastic fiber with flex relief</li> <li>• 1 mm core diameter</li> <li>• Threaded nickel plated brass</li> </ul>	25 mm	DF-G1 245	1 m	PIT43UM3-VL
			DF-G2 640		PIT46UM3-VL
			DF-G3 2320	2 m	
 M4	<ul style="list-style-type: none"> <li>• Plastic fiber with flex relief</li> <li>• 1 mm core diameter</li> <li>• Threaded nickel plated brass</li> <li>• M2.6 threaded lens mount</li> </ul>	25 mm	DF-G1 220	1 m	PIT43U-VL
			DF-G2 590		PIT46U-VL
			DF-G3 2140	2 m	
 M4	<ul style="list-style-type: none"> <li>• Plastic fiber with flex relief</li> <li>• 1 mm core diameter</li> <li>• Threaded Stainless Steel</li> <li>• M2.6 threaded lens mount</li> </ul>	25 mm	DF-G1 170	1 m	PIAT43UTA-VL
			DF-G2 455		PIAT46UTA-VL
			DF-G3 1660	2 m	
 M4	<ul style="list-style-type: none"> <li>• Plastic fiber with flex relief</li> <li>• 1 mm core diameter</li> <li>• Threaded Stainless Steel</li> <li>• M2.6 threaded lens mount</li> </ul>	2 mm	DF-G1 190	1 m	PIAT43UHFTA-VL
			DF-G2 500		PIAT46UHFTA-VL
			DF-G3 1850	2 m	
 M4	<ul style="list-style-type: none"> <li>• Stainless monocoil jacket</li> <li>• 1 mm core diameter</li> <li>• Threaded Stainless Steel</li> <li>• M2.6 threaded lens mount</li> </ul>	25 mm	DF-G1 240	1 m	PIT43TSL5-VL
			DF-G2 630		PIT46TSL5-VL
			DF-G3 2300	2 m	
 M4	<ul style="list-style-type: none"> <li>• Stainless monocoil jacket</li> <li>• 1 mm core diameter</li> <li>• Threaded Stainless Steel</li> <li>• M2.6 threaded lens mount</li> </ul>	25 mm	DF-G1 60	1 m	PIAT43TSL5TA-VL
			DF-G2 150		PIAT46TSL5TA-VL
			DF-G3 560	2 m	
 M4	<ul style="list-style-type: none"> <li>• Plastic fiber with flex relief</li> <li>• 30 x 0.25 mm core diameter</li> <li>• Plastic housing</li> <li>• Smallest detectable object 2 mm**</li> <li>• 14.5 mm wide sensing area</li> </ul>	60 mm	DF-G1 230	1 m	PIR1X323T-VL
			DF-G2 600		PIR1X326T-VL
			DF-G3 2180	2 m	

 Cut to custom length

\* Typical range shown is with a 2 m model

\*\* Smallest detectable object achievable with emitter and receiver spaced 50 mm apart

## Diffuse Fibers

Fiber Head	Description	Minimum Bend Radius	Typical Range* (mm)	Fiber Length	Model
 M3	<ul style="list-style-type: none"> <li>Plastic fiber with flex relief</li> <li>0.5 mm core diameter</li> <li>Threaded nickel plated brass</li> </ul>	15 mm	DF-G1 25	1 m	PBT23U-VL
			DF-G2 70		PBT26U-VL
			DF-G3 250	2 m	
 M4	<ul style="list-style-type: none"> <li>Plastic fiber with flex relief</li> <li>0.5 mm core diameter</li> <li>Threaded nickel plated brass</li> </ul>	15 mm	DF-G1 25	1 m	PBT23UM4-VL
			DF-G2 60		PBT26UM4-VL
			DF-G3 230	2 m	
 M6	<ul style="list-style-type: none"> <li>Plastic fiber with flex relief</li> <li>1 mm core diameter</li> <li>Threaded nickel plated brass</li> </ul>	25 mm	DF-G1 75	1 m	PBT43U-VL
			DF-G2 200		PBT46U-VL
			DF-G3 715	2 m	
 M6	<ul style="list-style-type: none"> <li>Plastic fiber with flex relief</li> <li>1 mm core diameter</li> <li>Threaded Stainless Steel</li> </ul>	25 mm	DF-G1 45	1 m	PBAT43UTA-VL
			DF-G2 120		PBAT46UTA-VL
			DF-G3 440	2 m	
 M6	<ul style="list-style-type: none"> <li>Plastic fiber with flex relief</li> <li>1 mm core diameter</li> <li>Threaded Stainless Steel</li> </ul>	2 mm	DF-G1 55	1 m	PBAT43UHFTA-VL
			DF-G2 140		PBAT46UHFTA-VL
			DF-G3 520	2 m	
 M6	<ul style="list-style-type: none"> <li>Stainless monocoil jacket</li> <li>1 mm core diameter</li> <li>Threaded Stainless Steel</li> </ul>	25 mm	DF-G1 80	1 m	PBT43TSL5-VL
			DF-G2 200		PBT46TSL5-VL
			DF-G3 740	2 m	
 M6	<ul style="list-style-type: none"> <li>Stainless monocoil jacket</li> <li>1 mm core diameter</li> <li>Threaded Stainless Steel</li> </ul>	25 mm	DF-G1 30	1 m	PBAT43TSL5TA-VL
			DF-G2 90		PBAT46TSL5TA-VL
			DF-G3 315	2 m	
 PBR1X323U-VL	<ul style="list-style-type: none"> <li>Plastic fiber with flex relief</li> <li>3 x 0.25 mm core diameter</li> <li>Plastic housing</li> <li>Smallest detectable object 1 mm**</li> <li>14.5 mm wide sensing area</li> </ul>	25 mm	DF-G1 55	1 m	PBR1X323U-VL
			DF-G2 140		PBR1X326U-VL
			DF-G3 515	2 m	

 Cut to custom length

\* Typical range shown is with a 2 m model

\*\* Smallest detectable object measured using a metal pin with BRT-92x92CB retro-reflector placed 50 mm from fiber face

## Plastic Fiber Cutter



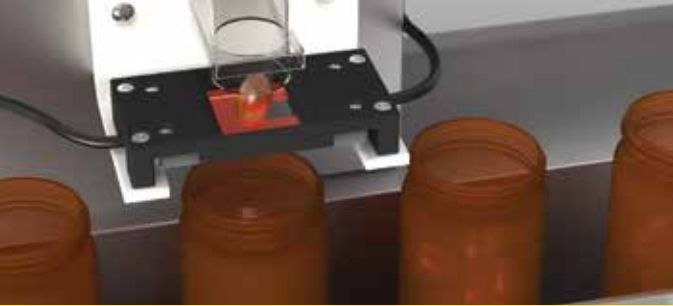

# Array and Slot Fibers

- Small part counting applications
- Edge guiding applications
- Quick and easy setup and alignment



Fiber Head	Description	Minimum Bend Radius	Typical Range* (mm)	Fiber Length	Model
	<ul style="list-style-type: none"> <li>• Sold as a pre-mounted pair</li> <li>• 16 x 0.25 mm core diameter</li> <li>• Smallest detectable object 3 mm**</li> <li>• Sensing area 25 x 25 mm</li> </ul>	5 mm	25	2 m	PFCVA-25X25-E
	<ul style="list-style-type: none"> <li>• Sold as a pre-mounted pair</li> <li>• 16 x 0.25 mm core diameter</li> <li>• Smallest detectable object 1.5 mm**</li> <li>• Sensing area 10 x 25 mm</li> </ul>	5 mm	25	2 m	PFCVA-10X25-S
	<ul style="list-style-type: none"> <li>• Plastic fiber with flex relief</li> <li>• Sold as a pair</li> <li>• Plastic housing</li> <li>• Smallest detectable object 2 mm**</li> <li>• 14.5 mm wide sensing area</li> </ul>	60 mm	DF-G1 230 DF-G2 600 DF-G3 2180	1 m  2 m	PIR1X323T-VL  PIR1X326T-VL
	<ul style="list-style-type: none"> <li>• Sold as a pair</li> <li>• Protective die-cast zinc housing</li> <li>• Smallest detectable object 1.5 mm**</li> <li>• 40 mm wide sensing area</li> </ul>	40 mm	DF-G1 220 DF-G2 570 DF-G3 2090	2 m 	PGIRS66U-40
	<ul style="list-style-type: none"> <li>• Sold as a pair</li> <li>• Protective die-cast zinc housing</li> <li>• Smallest detectable object 3 mm**</li> <li>• 100 mm wide sensing area</li> </ul>	40 mm	DF-G1 220 DF-G2 570 DF-G3 2090	2 m 	PGIRS66U-100
	<ul style="list-style-type: none"> <li>• Plastic fiber with flex relief</li> <li>• Sold as a pair</li> <li>• Metal housing</li> <li>• Smallest detectable object 1.25 mm**</li> <li>• 40 mm wide sensing area</li> </ul>	60 mm	DF-G1 215 DF-G2 560 DF-G3 2045	2 m 	PIRSL1X326T5-40
	<ul style="list-style-type: none"> <li>• Sold as a pair</li> <li>• Aluminium housing</li> <li>• Smallest detectable object 0.5 mm**</li> <li>• Ideal for compact web guiding</li> <li>• 5.25 mm wide sensing area</li> </ul>	5 mm	DF-G1 190 DF-G2 495 DF-G3 1800	2 m 	PIRS1X166U
	<ul style="list-style-type: none"> <li>• Sold as a pair</li> <li>• Aluminium housing</li> <li>• Smallest detectable object 0.75 mm**</li> <li>• Ideal for compact web guiding</li> <li>• 5.25 mm wide sensing area</li> </ul>	5 mm	DF-G1 185 DF-G2 485 DF-G3 1770	2 m 	PIRS1X166U

Cut to custom length

\* Typical range shown is with a 2 m model

\*\* Smallest detectable object achievable with emitter and receiver spaced 50 mm apart

## Diffuse Fibers

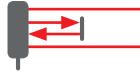

Fiber Head	Description	Minimum Bend Radius	Typical Range* (mm)	Fiber Length	Model	
	<ul style="list-style-type: none"> <li>Plastic fiber with flex relief</li> <li>Plastic housing</li> <li>Smallest detectable object 1 mm</li> <li>14.5 mm wide sensing area</li> </ul>	25 mm	DF-G1 55	1 m	<b>PBR1X323U-VL</b>	
			DF-G2 140			
			DF-G3 515	2 m	<b>PBR1X326U-VL</b>	
	<ul style="list-style-type: none"> <li>Aluminum housing</li> <li>Smallest detectable object 0.25 mm**</li> <li>10.9 mm wide sensing area</li> </ul>	5 mm	DF-G1 60	2 m	<b>PBR1X326U</b>	
			DF-G2 160			
			DF-G3 575			
	<ul style="list-style-type: none"> <li>Aluminium housing</li> <li>Smallest detectable object 0.25 mm**</li> <li>10.9 mm wide sensing area</li> </ul>	5 mm	DF-G1 50	2 m	<b>PBR51X326U</b>	
			DF-G2 125			
			DF-G3 450			
	<ul style="list-style-type: none"> <li>Plastic fiber with flex relief</li> <li>Metal housing</li> <li>Smallest detectable object 0.25 mm**</li> <li>20 mm wide sensing area</li> </ul>	25 mm	DF-G1 30	2 m	<b>PBR51X326U</b>	
			DF-G2 75			
			DF-G3 275			

Cut to custom length

\* Typical range shown is with a 2 m model

\*\* Smallest detectable object measured using a metal pin with BRT-92x92CB retro-reflector placed 50mm from fiber face

## Slot Fibers

Fiber Head	Description	Minimum Bend Radius	Slot Width (mm)	Fiber Length	Model
	<ul style="list-style-type: none"> <li>Plastic fiber with flex relief</li> <li>Metal housing</li> <li>32 beams</li> <li>Ideal for edge guiding</li> </ul>	60 mm	20 mm	2 m	<b>PDIRS1X326T5-20</b>
	<ul style="list-style-type: none"> <li>Plastic housing</li> <li>Single beam</li> </ul>	2 mm	12 mm	2 m	<b>PDIS46UM12</b>
	<ul style="list-style-type: none"> <li>Plastic housing</li> <li>Single beam</li> </ul>	8 mm	5 mm	2 m	<b>PDIS16UM5</b>









Cut to custom length



# Heavy Duty Fibers

- Resist kinking, cutting and snagging
- Opposed models come as a pair
- STEELSKIN sheathing allows for protection with a tight bend radius

## Opposed Fibers









Fiber Head	Description	Minimum Bend Radius	Typical Range* (mm)	Fiber Length	Model
 M4	<ul style="list-style-type: none"> <li>• Plastic fiber</li> <li>• 1 mm core diameter</li> <li>• STEELSKIN sheathing</li> <li>• Threaded Stainless steel</li> <li>• M2.6 threaded lens mount</li> </ul>	12 mm	DF-G1 175	1 m	PIAT43TMB5
			DF-G2 460	2 m	
			DF-G3 1690	2 m	PIAT46TMB5
 M4	<ul style="list-style-type: none"> <li>• Plastic fiber</li> <li>• 1 mm core diameter</li> <li>• STEELSKIN sheathing</li> <li>• Stainless steel Ferrule tip</li> </ul>	12 mm	DF-G1 185	1 m	PIF43TMB5
			DF-G2 490	2 m	PIF46TMB5
			DF-G3 1780	2 m	PIF46TMB5
 M4	<ul style="list-style-type: none"> <li>• Plastic fiber</li> <li>• 1 mm core diameter</li> <li>• STEELSKIN sheathing</li> <li>• 51 mm Stainless steel side-view probe</li> </ul>	12 mm	DF-G1 125	1 m	PIPS43TMB5
			DF-G2 330	2 m	PIPS46TMB5
			DF-G3 1200	2 m	PIPS46TMB5
 M4	<ul style="list-style-type: none"> <li>• Plastic fiber</li> <li>• Smallest detectable object 1 mm**</li> <li>• STEELSKIN sheathing</li> <li>• Aluminium side-view array</li> <li>• 10 mm wide sensing area</li> </ul>	12 mm	DF-G1 210	1 m	PIRS1X163TMB5M.4
			DF-G2 555	2 m	PIRS1X166TMB5M.4
			DF-G3 2025	2 m	PIRS1X166TMB5M.4
 M4	<ul style="list-style-type: none"> <li>• Plastic fiber with flex relief</li> <li>• Smallest detectable object 3.5 mm**</li> <li>• STEELSKIN sheathing</li> <li>• Plastic side-view array</li> <li>• 56 mm wide sensing area</li> </ul>	12 mm	DF-G1 190	2 m	PIRS1X166TMB5M2
			DF-G2 490	2 m	
			DF-G3 1800	2 m	
 M3	<ul style="list-style-type: none"> <li>• Plastic fiber</li> <li>• 0.5 mm core diameter</li> <li>• STEELSKIN sheathing</li> <li>• Threaded Stainless steel</li> </ul>	12 mm	DF-G1 50	1 m	PIT23TMB5M3
			DF-G2 140	2 m	PIT26TMB5M3
			DF-G3 510	2 m	PIT26TMB5M3
 M4	<ul style="list-style-type: none"> <li>• Plastic fiber</li> <li>• 1 mm core diameter</li> <li>• STEELSKIN sheathing</li> <li>• Threaded Stainless steel</li> <li>• M2.5 threaded lens mount</li> </ul>	12 mm	DF-G1 185	1 m	PIT43TMB5
			DF-G2 490	2 m	PIT46TMB5
			DF-G3 1775	2 m	PIT46TMB5
 M4	<ul style="list-style-type: none"> <li>• Stainless monocoil jacket</li> <li>• 1 mm core diameter</li> <li>• Threaded Stainless Steel</li> <li>• M2.6 threaded lens mount</li> </ul>	25 mm	DF-G1 240	1 m	PIT43TSL5-VL
			DF-G2 630	2 m	PIT46TSL5-VL
			DF-G3 2300	2 m	PIT46TSL5-VL
 M4	<ul style="list-style-type: none"> <li>• Stainless monocoil jacket</li> <li>• 1 mm core diameter</li> <li>• Threaded Stainless Steel</li> <li>• M2.6 threaded lens mount</li> </ul>	25 mm	DF-G1 60	1 m	PIAT43TSL5TA-VL
			DF-G2 150	2 m	PIAT46TSL5TA-VL
			DF-G3 560	2 m	PIAT46TSL5TA-VL

\* Typical range shown is with a 2 m model

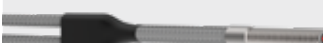
\*\* Smallest detectable object achievable with emitter and receiver spaced 50 mm apart

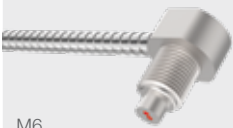

## Diffuse Fibers

Fiber Head	Description	Minimum Bend Radius	Typical Range* (mm)	Fiber Length	Model
 M6	<ul style="list-style-type: none"> <li>• Plastic fiber</li> <li>• 0.5 mm core diameter</li> <li>• STEELSKIN sheathing</li> <li>• Threaded Stainless steel</li> </ul>	12 mm	DF-G1 40	1 m	PBAT43TMB5MTA
			DF-G2 110	2 m	
			DF-G3 400		
 M3	<ul style="list-style-type: none"> <li>• Coaxial Plastic fiber</li> <li>• 0.5 mm &amp; 9 x 0.25 mm core diameter</li> <li>• STEELSKIN sheathing</li> <li>• Threaded Stainless steel</li> </ul>	12 mm	DF-G1 30	1 m	PBCT23TMB5
			DF-G2 75	2 m	PBCT26TMB5
			DF-G3 275		
 M4	<ul style="list-style-type: none"> <li>• Coaxial Plastic fiber</li> <li>• 0.5 mm &amp; 9 x 0.25 mm core diameter</li> <li>• STEELSKIN sheathing</li> <li>• Threaded Stainless steel</li> </ul>	12 mm	DF-G1 30	1 m	PBCT23TMB5M4
			DF-G2 75	2 m	PBCT26TMB5M4
			DF-G3 275		
 M4	<ul style="list-style-type: none"> <li>• Coaxial Plastic fiber</li> <li>• 0.5 mm &amp; 9 x 0.25 mm core diameter</li> <li>• STEELSKIN sheathing</li> <li>• Threaded Stainless steel</li> </ul>	12 mm	DF-G1 20	1 m	PBCT23TMB5MTA
			DF-G2 55	2 m	PBCT26TMB5MTA
			DF-G3 200		
 	<ul style="list-style-type: none"> <li>• Plastic fiber</li> <li>• 1 mm core diameter</li> <li>• STEELSKIN sheathing</li> <li>• 51 mm Stainless steel side-view probe</li> </ul>	12 mm	DF-G1 35	1 m	PBPS43TMB5
			DF-G2 90	2 m	PBPS46TMB5
			DF-G3 340		
 M6	<ul style="list-style-type: none"> <li>• Plastic fiber</li> <li>• 1 mm core diameter</li> <li>• Stainless monocoil jacket</li> <li>• Threaded Stainless steel</li> </ul>	25 mm	DF-G1 125	1 m	PBT43TSL5-VL
			DF-G2 325	2 m	PBT46TSL5-VL
			DF-G3 1190		
 M6	<ul style="list-style-type: none"> <li>• Plastic fiber</li> <li>• 1 mm core diameter</li> <li>• Stainless monocoil jacket</li> <li>• Threaded Stainless steel</li> </ul>	25 mm	DF-G1 110	1 m	PBAT43TSL5TA-VL
			DF-G2 280	2 m	PBAT46TSL5TA-VL
			DF-G3 1030		
 M6	<ul style="list-style-type: none"> <li>• Plastic fiber</li> <li>• 1 mm core diameter</li> <li>• STEELSKIN sheathing</li> <li>• Threaded Stainless steel</li> </ul>	12 mm	DF-G1 50	1 m	PBT43TMB5
			DF-G2 135	2 m	PBT46TMB5
			DF-G3 490		

\* Typical range shown is with a 2 m model



# Tight Bend Fibers

- Minimal transmission loss under extreme bend radius
- Bend radius of 1-5 mm

## Opposed Fibers

Fiber Head	Description	Minimum Bend Radius	Typical Range* (mm)	Fiber Length	Model
 M4	<ul style="list-style-type: none"> <li>• 1 mm core diameter</li> <li>• Threaded Nickel plated brass</li> <li>• M2.5 threaded tip</li> </ul>	2 mm	DF-G1 140	2 m ✂️	PIT46UHF
			DF-G2 365		
			DF-G3 1335		
 M4	<ul style="list-style-type: none"> <li>• Plastic fiber with flex relief</li> <li>• 1 mm core diameter</li> <li>• Threaded Nickel plated brass</li> <li>• M2.6 threaded tip</li> </ul>	2 mm	DF-G1 190	1 m	PIAT43UHFTA-VL
			DF-G2 500	✂️	PIAT46UHFTA-VL
			DF-G3 1830	2 m	
 M4	<ul style="list-style-type: none"> <li>• 1 mm core diameter</li> <li>• Threaded stainless steel</li> <li>• M2.5 threaded tip</li> </ul>	2 mm	DF-G1 155	2 m ✂️	PIAT46UHFMFTA
			DF-G2 410		
			DF-G3 1500		

\* Typical range shown is with a 2 m model

## Diffuse Fibers

Fiber Head	Description	Minimum Bend Radius	Typical Range* (mm)	Fiber Length	Model
 M6	<ul style="list-style-type: none"> <li>• 1 mm core diameter</li> <li>• Threaded Nickel plated brass</li> </ul>	2 mm	DF-G1 35	2 m ✂️	PBT46UHF
			DF-G2 90		
			DF-G3 330		
 M6	<ul style="list-style-type: none"> <li>• Plastic fiber with flex relief</li> <li>• 1 mm core diameter</li> <li>• Threaded stainless steel</li> </ul>	2 mm	DF-G1 55	1 m	PBAT43UHFTA-VL
			DF-G2 140	✂️	PBAT46UHFTA-VL
			DF-G3 515	2 m	
 M4	<ul style="list-style-type: none"> <li>• 1 mm core diameter</li> <li>• Threaded stainless steel</li> </ul>	2 mm	DF-G1 45	2 m ✂️	PBAT46UHFMFTA
			DF-G2 115		
			DF-G3 415		

✂️ Cut to custom length

\* Typical range shown is with a 2 m model

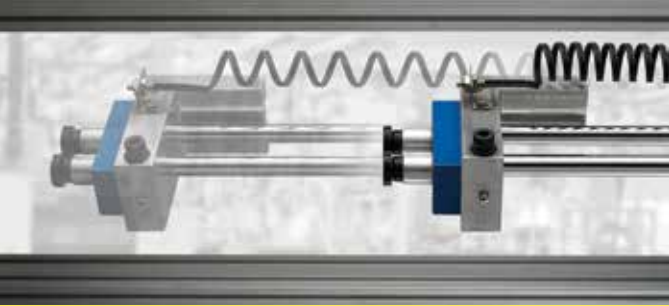







# Retractable Fibers

- 10,000 or more repeat linear motion cycles
- Fiber is coiled to prevent tangle of loose cable

## Opposed Fibers

Fiber Head	Description	Minimum Bend Radius	Typical Range (mm)	Fiber Length	Model
 M4	<ul style="list-style-type: none"> <li>• 1 mm core diameter</li> <li>• 10,000+ flexes</li> <li>• Threaded stainless steel</li> <li>• M2.5 threaded tip</li> </ul>	25 mm	DF-G1 200	2 m 	PIAT46UC
			DF-G2 525		
			DF-G3 1915		
 M4	<ul style="list-style-type: none"> <li>• 1 mm core diameter</li> <li>• 10,000+ flexes</li> <li>• Nickel plated brass</li> <li>• 89 mm long probe tip</li> </ul>	25 mm	DF-G1 200	2 m 	PIP46UC
			DF-G2 525		
			DF-G3 1915		
 M4	<ul style="list-style-type: none"> <li>• 1 mm core diameter</li> <li>• 10,000+ flexes</li> <li>• Nickel plated brass</li> <li>• M2.5 threaded tip</li> </ul>	25 mm	DF-G1 200	2 m 	PIT46UC
			DF-G2 525		
			DF-G3 1915		

## Diffuse Fibers

Fiber Head	Description	Minimum Bend Radius	Typical Range (mm)	Fiber Length	Model
 M6	<ul style="list-style-type: none"> <li>• 1 mm core diameter</li> <li>• 10,000+ flexes</li> <li>• Threaded Nickel plated brass</li> <li>• 89 mm long Stainless steel probe tip</li> </ul>	25 mm	DF-G1 30	2 m 	PBP46UC
			DF-G2 80		
			DF-G3 285		
 M6	<ul style="list-style-type: none"> <li>• 1 mm core diameter</li> <li>• 10,000+ flexes</li> <li>• Threaded stainless steel</li> </ul>	25 mm	DF-G1 30	2 m 	PBT46UCMNF
			DF-G2 80		
			DF-G3 285		
 M6	<ul style="list-style-type: none"> <li>• 1 mm core diameter</li> <li>• 10,000+ flexes</li> <li>• Stainless steel Ferrule tip</li> </ul>	25 mm	DF-G1 30	2 m 	PBF46UC
			DF-G2 80		
			DF-G3 285		

 Cut to custom length



# Tube Liquid Detection

- Detects liquid level through transparent tubing
- Includes mounting straps
- No contact with liquid

Description	Minimum Bend Radius	Fiber Length	Model
<ul style="list-style-type: none"> <li>• Plastic convergent fiber</li> <li>• 1 mm core diameter</li> <li>• Compatible with 2 mm-25 mm tubes</li> </ul>	2 mm	2 m	<b>PDI46U-LLD</b>
		5 m	<b>PDI415U-LLD</b>



# Water Detection

- Opposed sensing solution
- Use with L2 lens and DF-G3LIR Fiber Amplifier

Description	Minimum Bend Radius	Fiber Length	Model*
<ul style="list-style-type: none"> <li>• Glass opposed fiber</li> <li>• 1 mm core diameter</li> <li>• 12 mm M4 thread tip</li> <li>• Stainless Steel sheath</li> </ul>	25 mm	1 m	<b>IT43ST5-VL</b>
		2 m	<b>IT46ST5-VL</b>

\* Sold individually



# Probe Liquid Detection

- Teflon® encapsulated
- Output switches when tip immersed in liquid

Description	Minimum Bend Radius	Fiber Length	Model
<ul style="list-style-type: none"> <li>• Plastic fiber</li> <li>• 1 mm core diameter</li> <li>• Probe length is 16.5 mm</li> </ul>	2 mm	2 m	<b>PBE46UTMLLP</b>
		5 m	<b>PBE415UTMLLP</b>

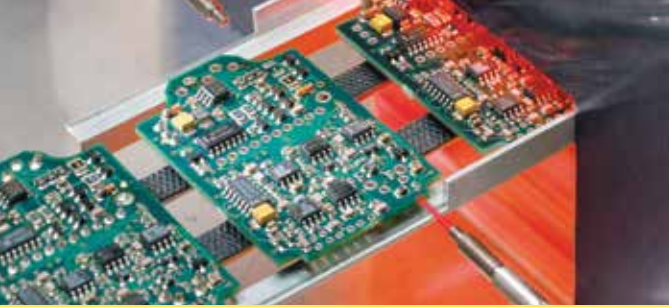

Cut to custom length



# High Temperature

- Terminated for use in plastic fiber sensors
- Stainless steel sheathing for harsh environments
- Can withstand temperatures up to 315 °C

## Opposed Fibers

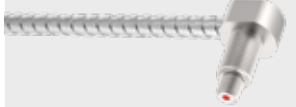
Fiber Head	Description	Minimum Bend Radius	Typical Range* (mm)	Fiber Length	Model**
 M4	<ul style="list-style-type: none"> <li>• Glass fiber</li> <li>• Rated 315° C at the tip</li> <li>• Stainless monocoil</li> <li>• Threaded Stainless steel</li> <li>• M2.5 threaded tip</li> </ul>	25 mm	DF-G1 120	2 m	IMT.756.6S-HT
			DF-G2 320		
			DF-G3 1160		
 M4	<ul style="list-style-type: none"> <li>• Glass fiber</li> <li>• Rated 249° C at the tip</li> <li>• Stainless monocoil</li> <li>• Threaded Stainless steel</li> <li>• M2.5 threaded tip</li> </ul>	25 mm	DF-G1 205	1 m	IT43ST5-VL
			DF-G2 540	2 m	IT46ST5-VL
			DF-G3 1965		
 M4	<ul style="list-style-type: none"> <li>• Glass fiber</li> <li>• Rated 249° C at the tip</li> <li>• Stainless monocoil</li> <li>• Threaded Stainless steel</li> <li>• M2.5 threaded tip</li> </ul>	25 mm	DF-G1 255	1 m	IAT43ST5TA-VL
			DF-G2 665	2 m	IAT46ST5TA-VL
			DF-G3 2425		

\* Typical range shown is with a 2 m model  
\*\* Sold individually

## Diffuse Fibers

Fiber Head	Description	Minimum Bend Radius	Typical Range* (mm)	Fiber Length	Model
 M4	<ul style="list-style-type: none"> <li>• Glass fiber</li> <li>• Rated 315° C at the tip</li> <li>• Stainless monocoil</li> <li>• Threaded Stainless steel</li> </ul>	25 mm	DF-G1 60	1 m	BMT13.33S-HT
			DF-G2 160	2 m	BMT16.6S-HT
			DF-G3 580		
 M4	<ul style="list-style-type: none"> <li>• Glass fiber</li> <li>• Rated 249° C at the tip</li> <li>• Stainless monocoil</li> <li>• Threaded Stainless steel</li> </ul>	25 mm	DF-G1 70	1 m	BT63ST5-VL
			DF-G2 185	2 m	BT66ST5-VL
			DF-G3 675		
 M4	<ul style="list-style-type: none"> <li>• Glass fiber</li> <li>• Rated 249° C at the tip</li> <li>• Stainless monocoil</li> <li>• Threaded Stainless steel</li> </ul>	25 mm	DF-G1 80	1 m	BAT63ST5TA-VL
			DF-G2 210	2 m	BAT66ST5TA-VL
			DF-G3 765		

\* Typical range shown is with a 2 m model

# Fiber Accessories

## Lenses

- Screw on lenses to focus the light beam even more
- Fixed/adjustable focus lenses have very small light spot for detecting small objects

Adjustable Focus	Opposed Fibers (for longer range)			Fixed Focus	
 <p><b>LZ3C8</b></p> <ul style="list-style-type: none"> <li>• Accepts M3 threaded fibers</li> <li>• Beam spot <math>\varnothing</math> 0.5-3.2 mm</li> </ul>	 <p><b>L2</b></p> <ul style="list-style-type: none"> <li>• Accepts M2.5 threaded fibers</li> <li>• Range extension</li> </ul>	 <p><b>L2RA</b></p> <ul style="list-style-type: none"> <li>• Accepts M2.6 threaded fibers</li> <li>• 90° beam deflection</li> <li>• Range extension</li> </ul>	 <p><b>L08FP</b></p> <ul style="list-style-type: none"> <li>• Accepts 2.2 mm outer diameter fiber jacket</li> <li>• M8 x 1.0 threaded acrylic lens</li> </ul>	 <p><b>L4C6</b></p> <ul style="list-style-type: none"> <li>• Accepts M4 threaded fibers</li> <li>• Beam spot <math>\varnothing</math> 0.25 mm @ 6 mm</li> </ul>	 <p><b>L4C20</b></p> <ul style="list-style-type: none"> <li>• Accepts M4 threaded fibers</li> <li>• Beam spot <math>\varnothing</math> 4 mm @ 20 mm</li> </ul>

## Brackets

 <p><b>SMBFP3</b></p> <ul style="list-style-type: none"> <li>• Mounting hole for M3 threads</li> <li>• 304 Stainless Steel</li> </ul>	 <p><b>SMBFP4</b></p> <ul style="list-style-type: none"> <li>• Mounting hole for M4 threads</li> <li>• 304 Stainless Steel</li> </ul>	 <p><b>SMBFP4N</b></p> <ul style="list-style-type: none"> <li>• Mounting hole for M4 threads</li> <li>• 304 Stainless Steel</li> </ul>	 <p><b>SMBFP6</b></p> <ul style="list-style-type: none"> <li>• Mounting hole for M6 threads</li> <li>• 304 Stainless Steel</li> </ul>
--	--	---	--

## Plastic Fiber Cutter



PFC-4 (qty 1)  
PFC-4-100 (qty 100)

# More Information Online

For the latest products, brackets, cordsets, accessories, and new solutions, find us on the web at [www.bannerengineering.com](http://www.bannerengineering.com).

You also have access to more detailed information such as engineering drawings, complete specifications, installation instructions, product configurators and product videos.

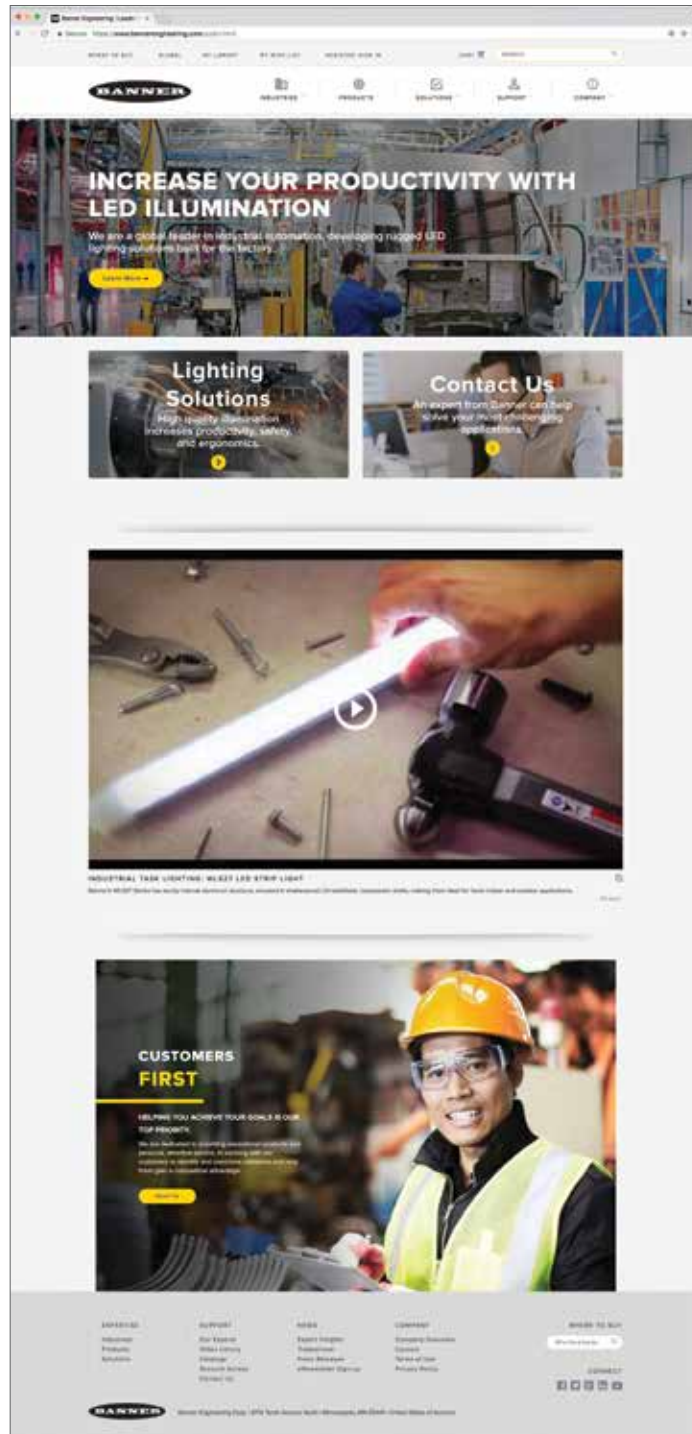



**Banner Engineering Corp.**

9714 Tenth Avenue North • Minneapolis, Minnesota 55441  
763-544-3164 • 1-888-373-6767

[www.bannerengineering.com](http://www.bannerengineering.com)